

Varenummer: 201223030

Beskrivelse: E+G Magnet m/gevindbøsning GN 50.25-HF-32
Hård ferrit - 220° C, 64N

Mål

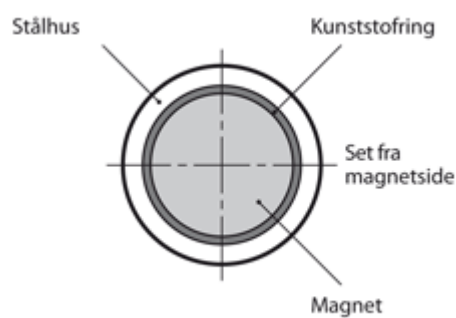

d1 = 32 ±0,1

d2 = M5x9

d3 = 8

h = 7 +0,3/-0,1

Holdekraft N = 64

Materiale = HF Hård ferrit - 220° C

t = 9